

1 Features

- Wide Supply Ranges
 - Single Supply: 3 V to 32 V (26 V for LM2902)
 - Dual Supplies: ± 1.5 V to ± 16 V (± 13 V for LM2902)
- Low Supply-Current Drain Independent of Supply Voltage: 0.8 mA Typical
- Common-Mode Input Voltage Range Includes Ground, Allowing Direct Sensing Near Ground
- Low Input Bias and Offset Parameters
 - Input Offset Voltage: 3 mV Typical
 - Input Offset Current: 2 nA Typical
 - Input Bias Current: 20 nA Typical
- Differential Input Voltage Range Equal to Maximum-Rated Supply Voltage: 32 V (26 V for LM2902)
- Open-Loop Differential Voltage Amplification: 100 V/mV Typical
- Internal Frequency Compensation
- On Products Compliant to MIL-PRF-38535, All Parameters are Tested Unless Otherwise Noted. On All Other Products, Production Processing Does Not Necessarily Include Testing of All Parameters.

2 Applications

- Blu-ray Players and Home Theaters
- Chemical and Gas Sensors
- DVD Recorders and Players
- Digital Multimeter: Bench and Systems
- Digital Multimeter: Handhelds
- Field Transmitter: Temperature Sensors
- Motor Control: AC Induction, Brushed DC, Brushless DC, High-Voltage, Low-Voltage, Permanent Magnet, and Stepper Motor
- Oscilloscopes
- TV: LCD and Digital
- Temperature Sensors or Controllers Using Modbus
- Weigh Scales

3 Description

These devices consist of four independent high-gain frequency-compensated operational amplifiers that are designed specifically to operate from a single supply or split supply over a wide range of voltages.

Symbol (Each Amplifier)

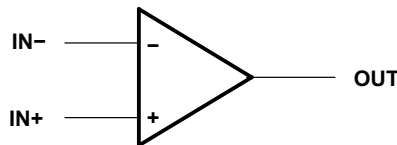

4 Pin Configuration and Functions

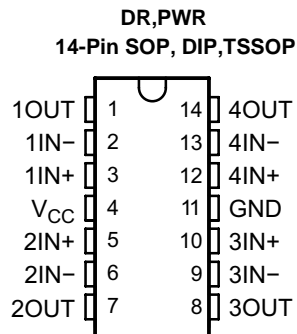

Pin Functions

PIN			I/O	DESCRIPTION
NAME	LCCC NO.	SOP, DIP		
1IN-		2	I	Negative input
1IN+		3	I	Positive input
1OUT		1	O	Output
2IN-		6	I	Negative input
2IN+		5	I	Positive input
2OUT		7	O	Output
3IN-		9	I	Negative input
3IN+		10	I	Positive input
3OUT		8	O	Output
4IN-		13	I	Negative input
4IN+		12	I	Positive input
4OUT		14	O	Output
GND		11	—	Ground
V _{CC}	6	4	—	Power supply

5 Specifications

5.1 Absolute Maximum Ratings

over operating free-air temperature range (unless otherwise noted)⁽¹⁾

	LM2902		LM124, LM224		UNIT
	MIN	MAX	MIN	MAX	
Supply voltage, V_{CC} ⁽²⁾	±13	26	±16	32	V
Differential input voltage, V_{ID} ⁽³⁾	±26		±32		V
Input voltage, V_I (either input)	-0.3	26	-0.3	to 32	V
Duration of output short circuit (one amplifier) to ground at (or below) $T_A = 25^\circ\text{C}$, $V_{CC} \leq 15\text{ V}$ ⁽⁴⁾	Unlimited		Unlimited		
Operating virtual junction temperature, T_J	150		150		°C
Storage temperature, T_{stg}	-65	150	-65	150	°C

- (1) Stresses beyond those listed under *Absolute Maximum Ratings* may cause permanent damage to the device. These are stress ratings only, and functional operation of the device at these or any other conditions beyond those indicated under *Recommended Operating Conditions* is not implied. Exposure to absolute-maximum-rated conditions for extended periods may affect device reliability.
- (2) All voltage values (except differential voltages and V_{CC} specified for the measurement of I_{OS}) are with respect to the network GND.
- (3) Differential voltages are at $IN+$, with respect to $IN-$.
- (4) Short circuits from outputs to V_{CC} can cause excessive heating and eventual destruction.

5.2 ESD

LM124, LM224, LM2902			
$V_{(ESD)}$ Electrostatic discharge	Human-body model (HBM), per ANSI/ESDA/JEDEC JS-001 ⁽¹⁾	±500	V
	Charged-device model (CDM), per JEDEC specification JESD22-C101	±1000	

- (1) JEDEC document JEP155 states that 500-V HBM allows safe manufacturing with a standard ESD control process.

5.3 Recommended Operating Conditions

over operating free-air temperature range (unless otherwise noted)

	LM2902		LM124, LM224		UNIT
	MIN	MAX	MIN	MAX	
V_{CC} Supply voltage	3	26	3	32	V
V_{CM} Common-mode voltage	0	$V_{CC} - 2$	0	$V_{CC} - 2$	V
T_A Operating free air temperature	LM124		-55	125	°C
	LM2902	-40	105		
	LM224		-20	85	

5.4 Thermal Information

THERMAL METRIC ⁽¹⁾	LM124, LM224, LM2902		
	(SOP)	(DIP)	UNIT
	14 PINS	14 PINS	
$R_{\theta JA}$ ⁽²⁾⁽³⁾ Junction-to-ambient thermal resistance	86	80	°C/W
$R_{\theta JC}$ ⁽⁴⁾ Junction-to-case (top) thermal resistance	—	—	

- (1) Short circuits from outputs to VCC can cause excessive heating and eventual destruction.
- (2) Maximum power dissipation is a function of $T_{J(max)}$, $R_{\theta JA}$, and T_A . The maximum allowable power dissipation at any allowable ambient temperature is $P_D = (T_{J(max)} - T_A)/R_{\theta JA}$. Operating at the absolute maximum T_J of 150°C can affect reliability.
- (3) Maximum power dissipation is a function of $T_{J(max)}$, $R_{\theta JA}$, and T_C . The maximum allowable power dissipation at any allowable case temperature is $P_D = (T_{J(max)} - T_C)/R_{\theta JC}$. Operating at the absolute maximum T_J of 150°C can affect reliability.

5.5 Electrical Characteristics for LMx24

at specified free-air temperature, $V_{CC} = 5\text{ V}$ (unless otherwise noted)

PARAMETER	TEST CONDITIONS ⁽¹⁾	T_A ⁽²⁾	LM124, LM224			UNIT	
			MIN	TYP ⁽³⁾	MAX		
V_{IO} Input offset voltage	$V_{CC} = 5\text{ V to MAX}$, $V_{IC} = V_{ICRmin}$, $V_O = 1.4\text{ V}$	25°C Full range	3 5 7			mV	
I_{IO} Input offset current	$V_O = 1.4\text{ V}$	25°C Full range	2 30 100			nA	
I_{IB} Input bias current	$V_O = 1.4\text{ V}$	25°C Full range	-20 -150 -300			nA	
V_{ICR} Common-mode input voltage range	$V_{CC} = 5\text{ V to MAX}$	25°C Full range	0 to $V_{CC} - 1.5$ 0 to $V_{CC} - 2$			V	
V_{OH} High-level output voltage	$R_L = 2\text{ k}\Omega$	25°C	$V_{CC} - 1.5$			V	
	$R_L = 10\text{ k}\Omega$	25°C					
	$V_{CC} = \text{MAX}$	Full range	26				
V_{OL} Low-level output voltage	$R_L \leq 10\text{ k}\Omega$	Full range	5 20			mV	
		Full range	27 28				
A_{VD} Large-signal differential voltage amplification	$V_{CC} = 15\text{ V}$, $V_O = 1\text{ V to }11\text{ V}$, $R_L \geq 2\text{ k}\Omega$	25°C Full range	50 100 25			V/mV	
CMRR Common-mode rejection ratio	$V_{IC} = V_{ICRmin}$	25°C	70 80			dB	
k_{SVR} Supply-voltage rejection ratio ($\Delta V_{CC}/\Delta V_{IO}$)		25°C	65 100			dB	
V_{O1}/V_{O2} Crosstalk attenuation	$f = 1\text{ kHz to }20\text{ kHz}$	25°C	120			dB	
I_O Output current	$V_{CC} = 15\text{ V}$, $V_{ID} = 1\text{ V}$, $V_O = 0$	Source	25°C	-20 -30 -60			mA
		Full range	-10				
	$V_{CC} = 15\text{ V}$, $V_{ID} = -1\text{ V}$, $V_O = 15\text{ V}$	Sink	25°C	10 20			
		Full range	5				
$V_{ID} = -1\text{ V}$, $V_O = 200\text{ mV}$	25°C	12 30			μA		
I_{OS} Short-circuit output current	V_{CC} at 5 V, $V_O = 0$, GND at -5 V	25°C	± 40 ± 60			mA	
I_{CC} Supply current (four amplifiers)	$V_O = 2.5\text{ V}$, no load	Full range	0.7 1.2			mA	
	$V_{CC} = \text{MAX}$, $V_O = 0.5 V_{CC}$, no load	Full range	1.4 3				

- (1) All characteristics are measured under open-loop conditions, with zero common-mode input voltage, unless otherwise specified. MAX V_{CC} for testing purposes is 26 V for LM2902 and 30 V for the others.
- (2) Full range is -55°C to 125°C for LM124, -20°C to 85°C for LM224
- (3) All typical values are at $T_A = 25^\circ\text{C}$

5.6 Operating Conditions

$V_{CC} = \pm 15\text{ V}$, $T_A = 25^\circ\text{C}$

PARAMETER		TEST CONDITIONS	TYP	UNIT
SR	Slew rate at unity gain	$R_L = 1\text{ M}\Omega$, $C_L = 30\text{ pF}$, $V_I = \pm 10\text{ V}$ (see Figure 7)	0.5	V/ μ s
B_1	Unity-gain bandwidth	$R_L = 1\text{ M}\Omega$, $C_L = 20\text{ pF}$ (see Figure 7)	1.2	MHz
V_n	Equivalent input noise voltage	$R_S = 100\ \Omega$, $V_I = 0\text{ V}$, $f = 1\text{ kHz}$ (see Figure 8)	35	nV/ $\sqrt{\text{Hz}}$

5.7 Typical Characteristics

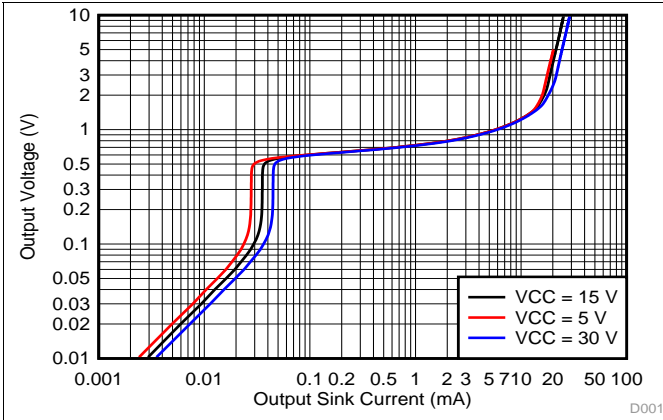

Figure 1. Output Sinking Characteristics

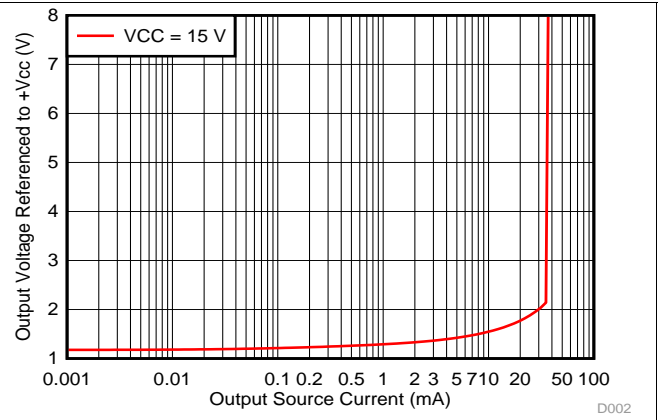

Figure 2. Output Sourcing Characteristics

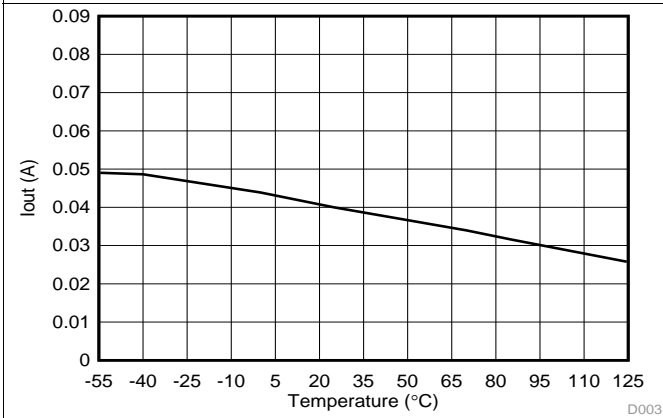

Figure 3. Source Current Limiting

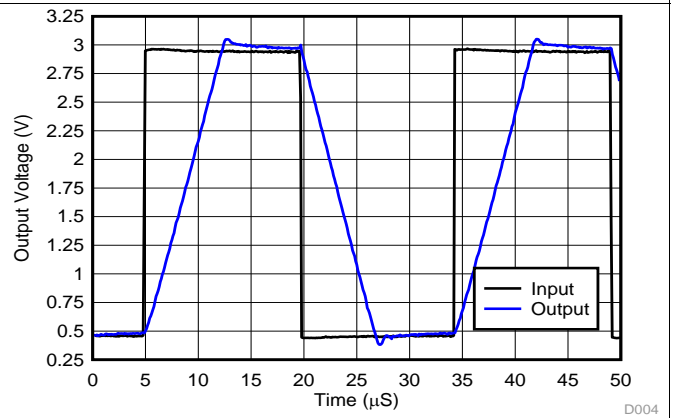

Figure 4. Voltage Follower Large Signal Response (50 pF)

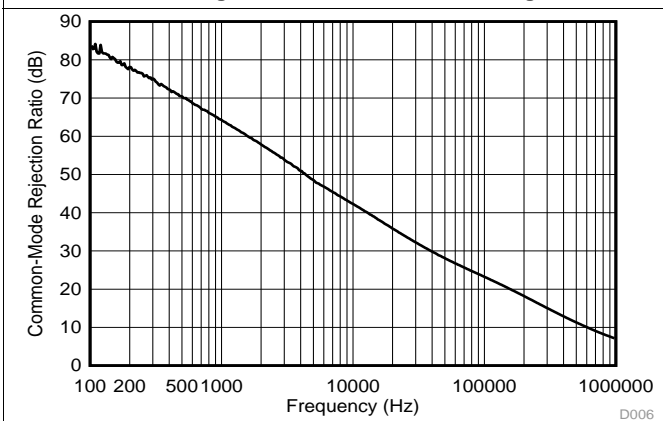

Figure 5. Common-Mode Rejection Ratio

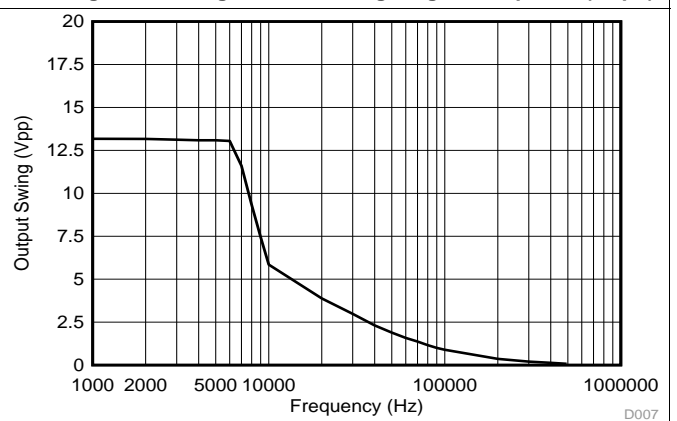

Figure 6. Maximum Output Swing vs. Frequency (VCC = 15 V)

6 Parameter Measurement Information

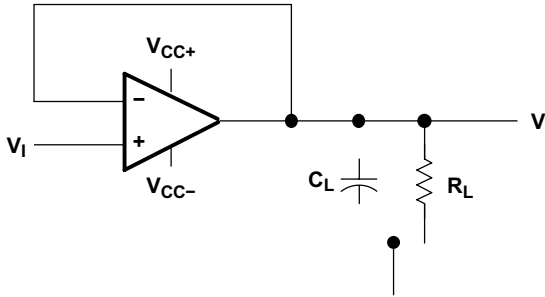

Figure 7. Unity-Gain Amplifier

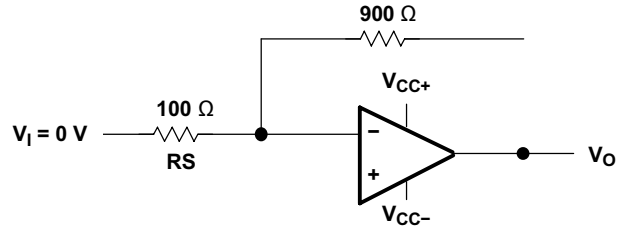

Figure 8. Noise-Test Circuit

7 Detailed Description

7.1 Overview

These devices consist of four independent high-gain frequency-compensated operational amplifiers that are designed specifically to operate from a single supply over a wide range of voltages. Operation from split supplies also is possible if the difference between the two supplies is 3 V to 32 V (3 V to 26 V for the LM2902 device), and V_{CC} is at least 1.5 V more positive than the input common-mode voltage. The low supply-current drain is independent of the magnitude of the supply voltage.

Applications include transducer amplifiers, DC amplification blocks, and all the conventional operational-amplifier circuits that now can be more easily implemented in single-supply-voltage systems. For example, the LM124 device can be operated directly from the standard 5-V supply that is used in digital systems and provides the required interface electronics, without requiring additional ± 15 -V supplies.

7.2 Functional Block Diagram

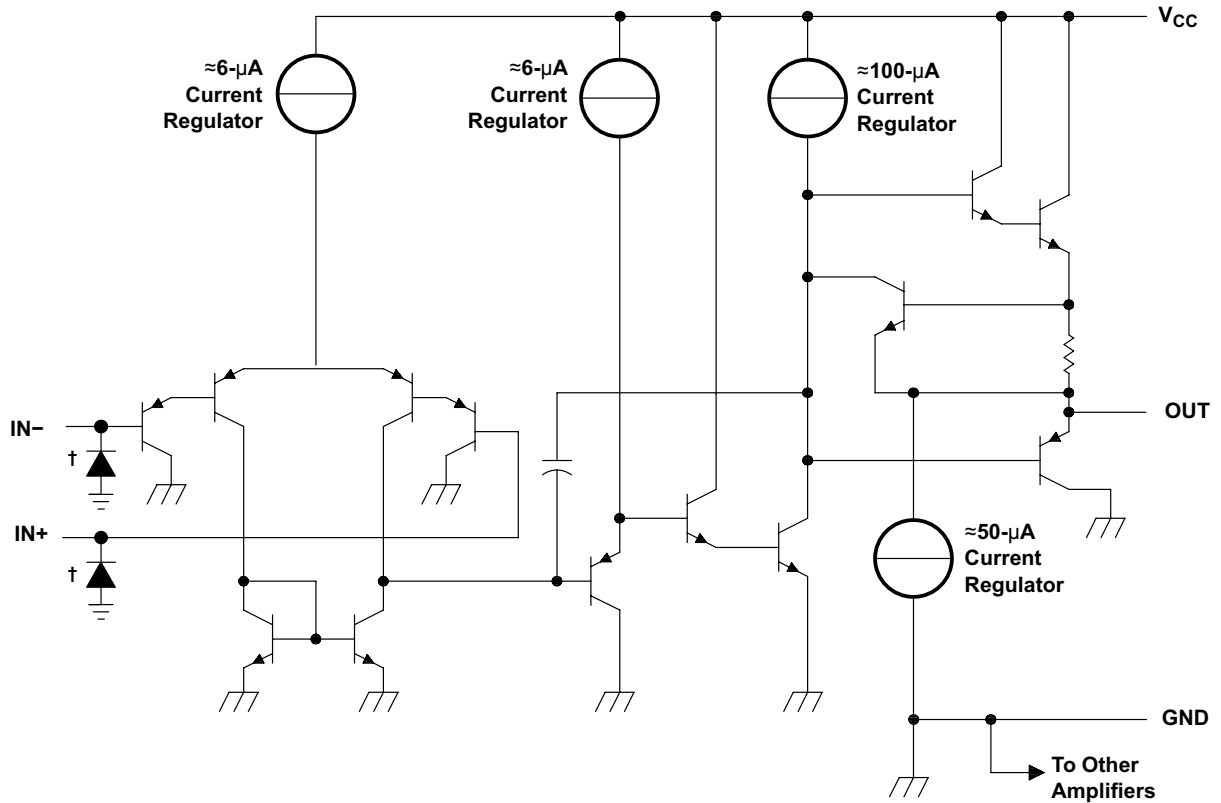

COMPONENT COUNT (total device)	
Epi-FET	1
Transistors	95
Diodes	4
Resistors	11
Capacitors	4

8.PACKAGE

SOP-14

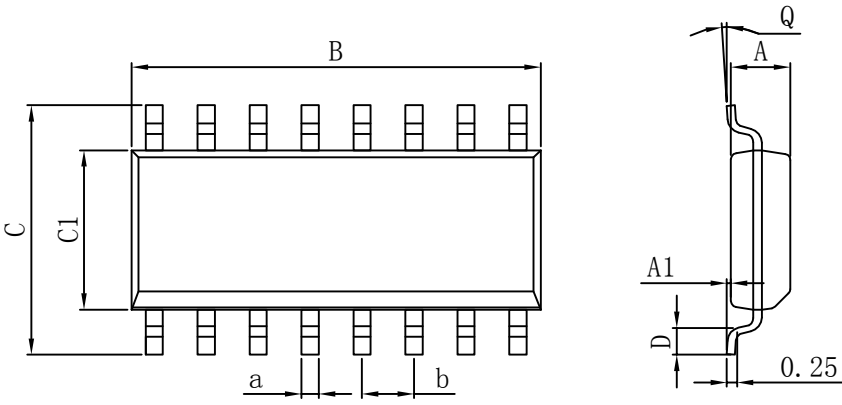

UNIT: mm							
DIM.	MIN	TYP	MAX	DIM.	MIN	TYP	MAX
A	4.520	4.570	4.620	a	0.400	0.420	0.440
A1	0.100	-	0.250	b	1.260	1.270	1.280
B	8.500	8.750	9.000	Q	0°	-	8°
C	5.800	6.100	6.250				
C1	3.800	3.900	4.000				
D	0.400	-	0.950				

DIP-14

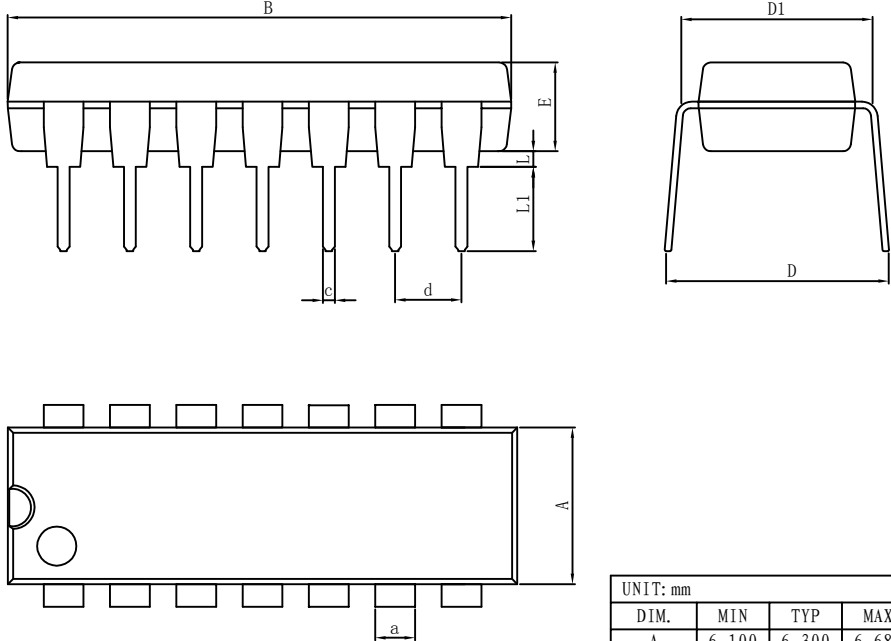

UNIT: mm							
DIM.	MIN	TYP	MAX	DIM.	MIN	TYP	MAX
A	6.100	6.300	6.680	a	1.504	1.524	1.544
B	18.940	19.200	19.560	c	0.437	0.457	0.477
D	8.200	8.700	9.200	d	2.530	2.540	2.550
D1	7.42	7.62	7.82	L	0.500	-	0.800
E	3.100	3.300	3.550	L1	3.000	3.200	3.600

TSSOP-14

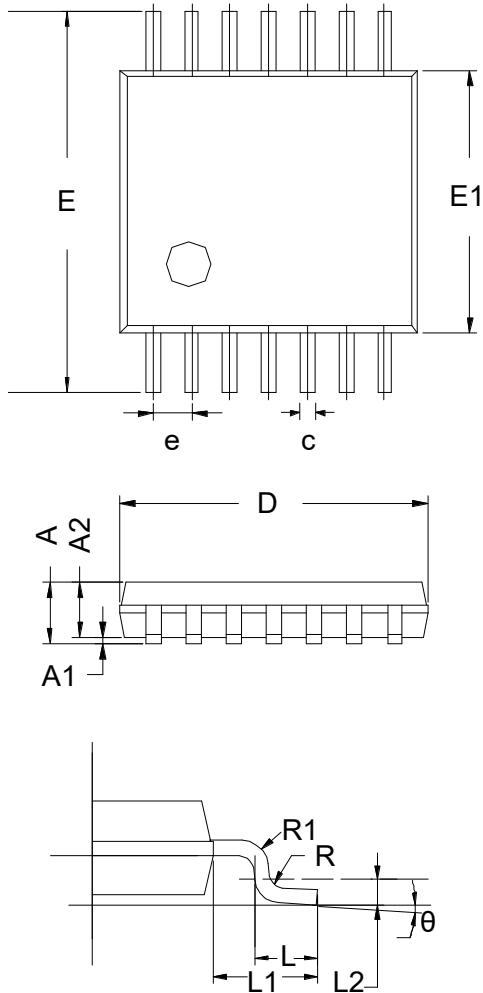

Symbol	Dimensions In Millimeters		
	MIN	TYP	MAX
A	-	-	1.20
A1	0.05	-	0.15
A2	0.90	1.00	1.05
b	0.20	-	0.28
c	0.10	-	0.19
D	4.86	4.96	5.06
E	6.20	6.40	6.60
E1	4.30	4.40	4.50
e	0.65 BSC		
L	0.45	0.60	0.75
L1	1.00 REF		
L2	0.25 BSC		
R	0.09	-	-
θ	0°	-	8°

9.ORDERING INFORMATION

Order Code	Package	Baseqty	Deliverymode
UMW LM124DR	SOP-14	2500	Tape and reel
UMW LM224DR	SOP-14	2500	Tape and reel
UMW LM2902DR	SOP-14	2500	Tape and reel
UMW LM2902PWR	TSSOP-14	2500	Tape and reel